

PINS AND BADGES

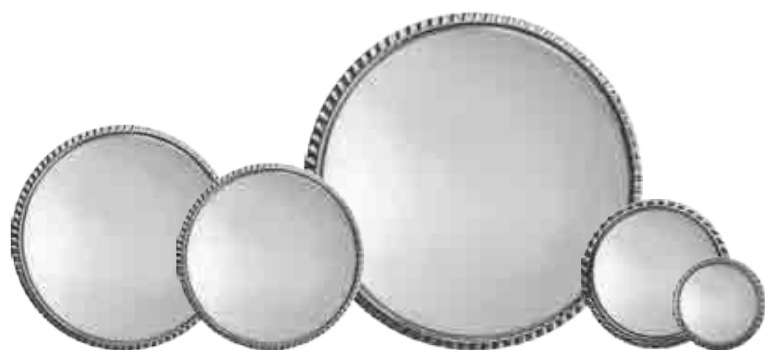



2044 G : 1.3 cm Metal Badge
2045 G : 2.2 cm Metal Badge
2046 G : 2.7 cm Metal Badge
2047 G : 3.7 cm Metal Badge
2048 G : 4.7 cm Metal Badge



2044 N : 1.3 cm Metal Badge
2045 N : 2.2 cm Metal Badge
2046 N : 2.7 cm Metal Badge
2047 N : 3.7 cm Metal Badge
2048 N : 4.7 cm Metal Badge



2044 B : 1.3 cm Metal Badge
2046 B : 2.7 cm Metal Badge
2047 N : 3.7 cm Metal Badge



Gold Round Rope Design Metal Badges

Optional backside : Pin, Butterfly Clutch or Magnet
Printing options : Digital Printing with Epoxy



Silver Round Rope Design Metal Badges

Optional backside : Pin, Butterfly Clutch or Magnet
Printing options : Digital Printing with Epoxy



Bronze Round Rope Design Metal Badges

Optional backside : Pin, Butterfly Clutch or Magnet
Printing options : Digital Printing with Epoxy



2040 G : 2.2 x 1.5 cm Metal Badge
2041 G : 3.8 x 2 cm Metal Badge
2042 G : 3.7 x 2.6 cm Metal Badge
2043 G : 4.7 x 3.1 cm Metal Badge

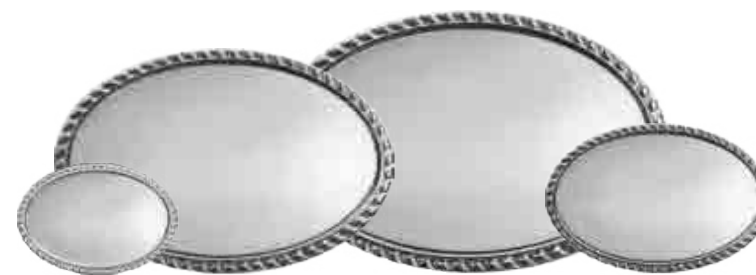

2040 N : 2.2 x 1.5 cm Metal Badge
2041 N : 3.8 x 2 cm Metal Badge
2042 N : 3.7 x 2.6 cm Metal Badge
2043 N : 4.7 x 3.1 cm Metal Badge

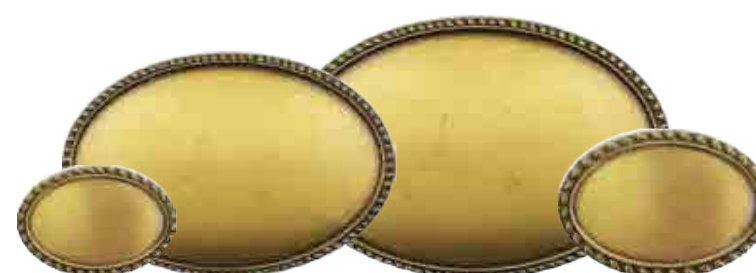

2040 B : 2.2 x 1.5 cm Metal Badge
2041 B : 3.8 x 2 cm Metal Badge
2042 B : 3.7 x 2.6 cm Metal Badge
2043 B : 4.7 x 3.1 cm Metal Badge



Gold Oval Rope Design Metal Badges

Optional backside : Pin, Butterfly Clutch or Magnet
Printing options : Digital Printing with Epoxy



Silver Oval Rope Design Metal Badges

Optional backside : Pin, Butterfly Clutch or Magnet
Printing options : Digital Printing with Epoxy



Bronze Oval Rope Design Metal Badges

Optional backside : Pin, Butterfly Clutch or Magnet
Printing options : Digital Printing with Epoxy



2037 G : 2 cm Metal Badge
2038 G : 2.5 cm Metal Badge
2039 G : 3.5 cm Metal Badge



2037 N : 2 cm Metal Badge
2038 N : 2.5 cm Metal Badge
2039 N : 3.5 cm Metal Badge

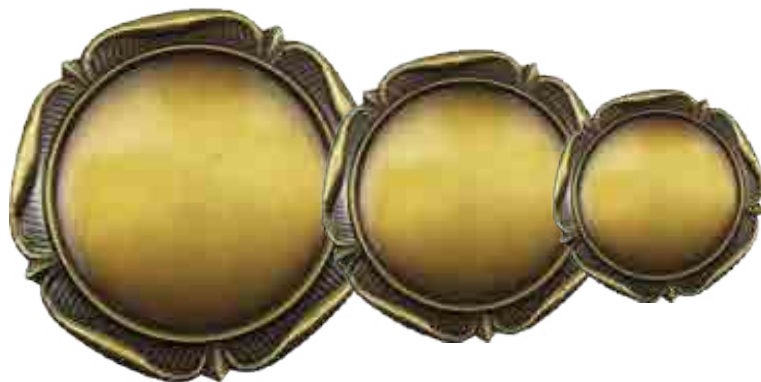

2037 B : 2 cm Metal Badge
2038 B : 2.5 cm Metal Badge
2039 B : 3.5 cm Metal Badge



Gold Round Flower Design Metal Badges

Optional backside : Pin, Butterfly Clutch or Magnet
Printing options : Digital Printing with Epoxy



Silver Round Flower Design Metal Badges

Optional backside : Pin, Butterfly Clutch or Magnet
Printing options : Digital Printing with Epoxy



Bronze Round Flower Design Metal Badges

Optional backside : Pin, Butterfly Clutch or Magnet
Printing options : Digital Printing with Epoxy



2029 - G / N : 4.5 x 2 cm Metal Badge
2028 - G / N : 3.5 x 1.5 cm Metal Badge
2027 - G / N : 2.5 x 1.5 cm Metal Badge
2033 - G / N : 2.5 x 1.8 cm Metal Badge

Printing options : Digital Printing with Epoxy



2029 - G / N : 4.5 x 2 cm Metal Badge
2028 - G / N : 3.5 x 1.5 cm Metal Badge
2027 - G / N : 2.5 x 1.5 cm Metal Badge
2033 - G / N : 2.5 x 1.8 cm Metal Badge

Printing options : Digital Printing with Epoxy

Optional backside : Pin, Butterfly Clutch or Magnet

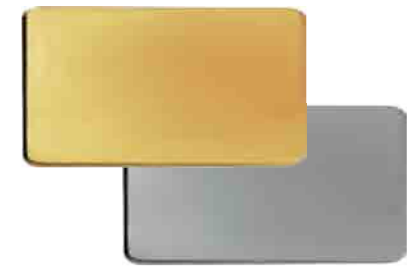

2031 - G / N : 3 x 1.7 cm Metal Badge

Backside : Butterfly Clutch
Printing options : Digital Printing with Epoxy

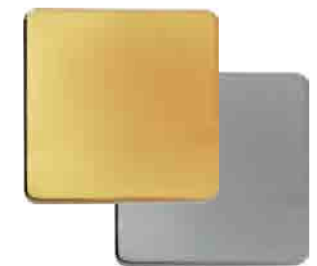

2030-22 - G / N : 2.2 x 2.2 cm Metal Badge
2030-18 - G / N : 1.8 x 1.8 cm Metal Badge

Backside : Butterfly Clutch
Printing options : Digital Printing with Epoxy



Arched Shaped Metal Badge

2049 - G / N : 3 x 3 cm Metal Badge
Backside : Butterfly Clutch
Printing options : Digital Printing with Epoxy



Silver Metal Badge

2053 N : 2.5 x 2.5 cm Metal Badge
Backside : Butterfly Clutch
Printing options : Digital Printing with Epoxy



NBD-19
UAE Nation Brand Metal Badge

Backside with Magnet.
 Available in silver & white badge.
Size : 3.9 x 2.9 cm



2082-G / 2082-N
I Love Badges

Backside with Butterfly Clutch.
Size : 3 x 2 cm



NBD-16
UAE Flag Metal Badge

Backside with Magnet.
Size : 3 x 3 cm



Round Shape Metal Badge

2115 : 2 x 2 cm Metal Badge
Backside : Butterfly Clutch
Printing options : Digital Printing with Epoxy



Heart Shape Metal Badge

2016 : 3 x 3.2 cm Metal Badge
Backside : Butterfly Clutch
Printing options : Digital Printing with Epoxy



NBD-17
UAE Flag Metal Badge

Backside with Magnet.
Size : 4 x 3 cm



NBD-18
Flag Ribbon Metal Badge

Backside with Magnet.
Size : 2.8 x 4.5 cm



2091 / 2092
Flag Metal Badge

2091 : Backside with Clutch
2092 : Backside with Magnet or Clutch
Size : 2 x 1.5 cm

Promotional Lapel Pins



2014-G

2010-G

2013-G

2013-N

2011-N

2010-N

2012-N



2081
Two Flag Metal Badge

Backside with Clutch.
Size : 3.5 x 2.5 cm



2094-N / 2094-G
Flag Metal Badge

Backside with Magnet or Clutch.
Size : 2.5 x 3.5 cm



2094-G-UAE
UAE Flag Metal Badge

With or without pin
Size : 2.5 x 3.5 cm



2101
Dubai Metal Badge

Debossed with colour filing. Backside with Magnet.
Size : 5 x 2.1 x 0.1 cm



NBD-21
UAE Flag Metal Badge

Backside with Magnet.
Size : 3.5 x 2 cm



LP-FWM10-KSA
KSA Flag Metal Badge

Backside with Magnet.
Size : 2 x 1.7 cm



2067
Promotional Glass Medal

Medal material : Glass
Size : 8 x 8 x 0.8 cm
Packing Size : 12 cm x 12 cm x 2.8 cm
Printing options : Laser Engraving, UV Printing.



2084-N
Silver Plated Pin Medal

Medal material : Metal with Pin
Round Area : 5.5 cm
Top Area : 5 x 1.5 cm
Printing options : Digital Printing with Epoxy.



LP-FLN20-KSA
KSA Flag Metal Badge

Backside with Magnet.
Size : 4 x 2 cm



2102
UAE Peace Sign Badge

Backside with Magnet.
Size : 2.8 x 3.5 cm



LP-BCP15 / LP-BCM20
Pink Ribbon Metal Badge

BCP15 : 2 x 3 cm with Clutch
BCM20 : 2 x 4 cm with Magnet



2055
Medal Pin Badge

Medal material : Metal with Pin
Size : 4.5 cm
Printing options : Digital Printing with Epoxy.



2080
Flag and Medal Badge

Medal material : Gold Plated with Pin
Medal Size : 4.2 cm | Flag Size : 4.2 x 2.5 cm
Printing options : Digital Printing with Epoxy.



LP-101B30
Black Round Metal Badge

Black Metal Badge with optional Magnet Attachment.
Size : 3 cm



2114-WP (Pin) / 2114 (Mag)
Smiley Design Metal Badges

Metal Badge with optional Magnet or Pin.
Size : 3 cm



2115-GR
I-am-Vaccinated Badge

Gold Metal Badge with enamel green round design. Magnet Attachment.
Size : 1.9 cm



2065 G/N/B
Gold / Silver / Bronze Medal

Includes Ribbon (White / UAE) - Flag Ribbon is Optional
Medal material : Metal | **Size :** 6.5 cm
Printing options : Digital Printing with Epoxy.



2064 G/N/B
Gold / Silver / Bronze Medal

Includes Ribbon (White / UAE) - Flag Ribbon is Optional
Medal material : Metal | **Size :** 5 cm
Printing options : Digital Printing with Epoxy.



2065-RW
Full White

2065R-UAE
UAE

2065R-OM
Oman

2065R-BH
Bahrain

2065R-KSA
KSA

2065R-G
Gold

2065R-SL
Silver

2065R-B
Bronze

CUSTOM MADE MEDALS

We are constantly creating new ideas that combines your design with metal medals, blend in with little masterpieces. The precisely developed design makes customers amazed with the output of medal. Promoting your logo in full color.



You can also choose from our pre-made basic cut medals:

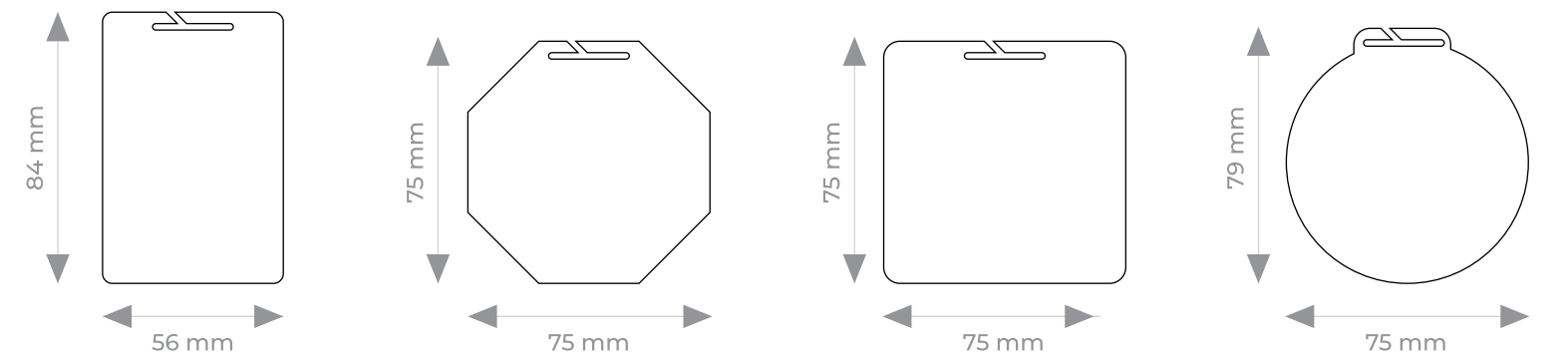

We have also offer a combination of metal & acrylic medals:

